

IR-CA SERIES HIGH-SPEED RADIATION THERMOMETER



The IR-CA Product Line of Non-Contact Infrared Thermometers provides broad selection of units to match your applications and requirements for non-contact temperature measurement. The product line consists of 15 different Series grouped into General Purpose and Application Specific models.



■ General Purpose Models

<i>Low Temperature – Long Wavelength</i>	IR-CAB□□□	IR-CAB Series measures temperatures as low as -50°C with an accuracy of $\pm 0.8^{\circ}\text{C}$.	Page 2
<i>Low Temperature – Short Wavelength</i>	IR-CAE□□□	IR-CAE Series measures temperature as low as 30°C with a very fast response time of 20 milliseconds. Because it operates at a relatively short wavelength, this series is ideal for measuring low temperature, unoxidized metals.	Page 2 & 3
<i>Low to Medium Temperature and Small Spot Size</i>	IR-CAP□□□	IR-CAP Series measures temperature as low as 80°C , with some models having measuring spot sizes as small as 1mm at a distance of 300mm. This series is ideal for measuring metals and measuring through quartz and glass windows.	Page 3
<i>Medium Temperature – Wide Temperature Range</i>	IR-CAI□□□	IR-CAI Series measures temperature as low as 200°C , provides temperatures spans as wide as 1300°C with ultra fast 3 millisecond response times.	Page 3
<i>High Temperature – Wide Temperature Range</i>	IR-CAS□□□	IR-CAS Series measures temperature as low as 500°C , provides temperatures spans as wide as 2400°C with ultra fast 3 millisecond response times.	Page 3
<i>Low Temperature-High Speed</i>	IR-CAK□□□	IR-CAK Series measures temperature as low as 50°C with a very fast response time of 1.5 milliseconds.	Page 4
<i>World's Widest Temperature Range Infrared Thermometer</i>	IR-CAW□□□	IR-CAW Series has an ultra wide temperature range of 20 to 3500°C in one single unit.	Page 4

■ Application Specific Models

<i>Polyester Film</i>	IR-CAN□□□	IR-CAN Series is designed to measure polyester films as thin as $12.5\mu\text{m}$. This unit operates at a wavelength that matches the PET absorption band. Temperature measurement can be made without affect of thickness and/or color.	Page 6
<i>Polyethylene Film</i>	IR-CAM□□□	IR-CAM Series is designed to measure polyethylene films as thin as $12.5\mu\text{m}$. This unit operates at a wavelength that matches the Carbon-Hydrogen absorption band. Temperature measurement can be made without affect of thickness and/or color.	Page 6
<i>Measurement Inside of Furnace</i>	IR-CAR□□□	IR-CAR Series is designed to look through hot combustion gases inside of a furnace. Its operating wavelength also minimizes background interference from hotter furnace walls.	Page 6
<i>Glass Temperature</i>	IR-CAG□□□	IR-CAG Series is designed to measure glass temperature. This unit utilizes a Thermoelectrically Cooled MCT IR Detector to provide a fast and stable temperature measurement.	Page 6
<i>Semicon/Silicon</i>	IR-CAT□□□	IR-CAT Series is designed to measure low temperature of Silicon wafers without seeing through the substrate therefore eliminating the interference of heaters/blocks.	Page 6
<i>Semicon/InGaAs</i>	IR-CAU□□□	IR-CAU Series is designed to measure low temperature of InGaAs wafers without seeing through the substrate therefore eliminating the interference of heaters/blocks.	Page 6
<i>Food Industry</i>	IR-CAFX0□	IR-CAFX0 Series is designed to measure Pasteurization temperatures (60 to 100°C) in the food industry, with high-speed (10 milliseconds) and high accuracy.	Page 7
<i>Hot Metal Detector</i>	IR-CADAC01	IR-CADAC01 Series is a HMD that detects the presence of hot metal on a production line. An Open Collector output is turned ON when hot metal enters the optical sensing path and exceeds the preset threshold level.	Page 7

■ SPECIFICATIONS

Low temperature/long wavelength IR-CAB□□□

Measuring system: Broadband radiation thermometer
 Element: PE
 Measuring wavelength: 8 to 13 μm
 Measuring range: -50 to 100°C or 20 to 1000°C
 Accuracy rating: ±0.8°C (-50 to 100°C)
 ±2°C (100 to 200°C)
 ±0.1% of measured value (200 to 1000°C)
 (at $\varepsilon \approx 1.0$ and reference operating conditions)
 Repeatability: 0.2°C or less (-50 to 100°C)
 1°C or less (20 to 1000°C)
 Stability: Temperature drift Lower than 100°C --- 0.05°C /°C
 100 to 700°C --- 0.05%/°C of measured value
 Higher than 700°C --- 0.025%/°C of measured value
 At EMC test environment... ±15% of measuring range
 Resolution: 0.1°C (-50 to 100°C)
 1°C (20 to 1000°C)
 Response time (95%): 2 sec (-50 to 100°C)
 0.2 sec (20 to 1000°C)
 Optics: Fixed focus lens type
 Sighting: Laser targeting without viewfinder
 Lens aperture: 15mm diameter
 Power consumption: Maximum 5VA
 (* The reference operating condition: 23°C ±5°C, 35 to 75%RH)

Relation between measuring distance and diameter

Measuring range: -50 to 100°C

Unit: mm

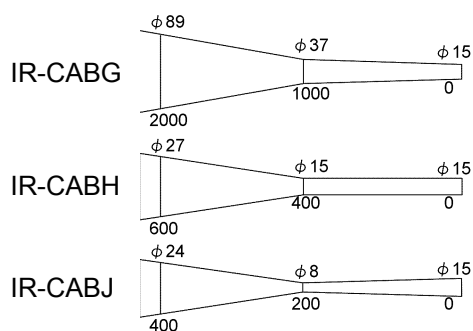

Measuring range: 20 to 1000°C

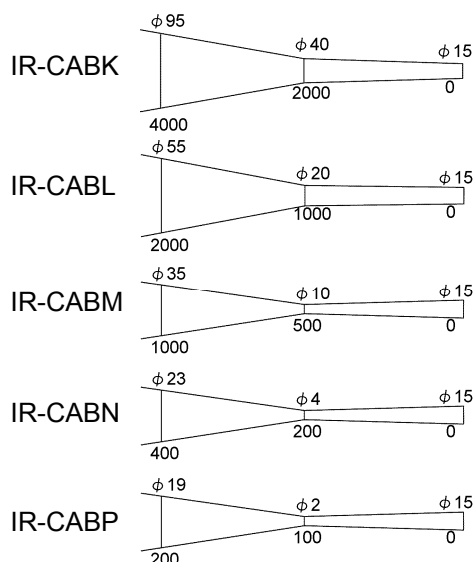

Low temperature/short wavelength IR-CAE□□□

Measuring system: Narrow-band radiation thermometer
 Element: PbSe
 Measuring wavelength: 4 μm
 Measuring range: 30 to 200°C
 Accuracy rating: ±2°C
 (at $\varepsilon \approx 1.0$ and reference operating conditions)
 Repeatability: 0.5°C or less
 Stability: Temperature drift 0.15°C /°C
 At EMC test environment... ±10% of measuring range
 Resolution: 0.1°C
 Response time (95%): 0.02 sec
 Optics: Fixed focus lens type
 Sighting: Laser targeting without viewfinder
 Lens aperture: 15mm diameter
 Power consumption: Maximum 10VA
 (* The reference operating condition: 23°C /°C ±5°C /°C, 35 to 75%RH)

Relation between measuring distance and diameter

Unit: mm

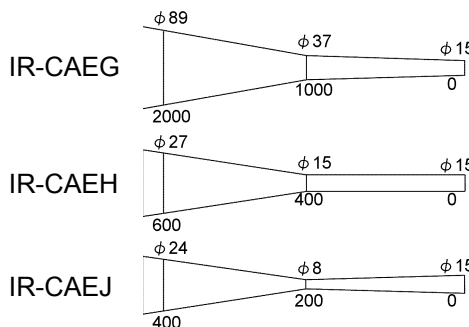

	Models	Measuring diameter/Measuring distance	Measuring range	Standard sighting
Low temperature /long wavelength	IR-CABG□□	Φ 37/1000mm	-50 to 100°C	Laser targeting (without view finder)
	IR-CABH□□	Φ 15/400mm		
	IR-CABJ□□	Φ 8/200mm		
	IR-CABK□□	Φ 40/2000mm	20 to 1000°C	
	IR-CABL□□	Φ 20/1000mm		
	IR-CABM□□	Φ 10/500mm		
	IR-CABN□□	Φ 4/200mm		
	IR-CABP□□	Φ 2/100mm		
IR-CABZ□□	Special	Ask CHINO		
Low temperature /short wavelength	IR-CAEG□□	Φ 37/1000mm	30 to 200°C	Ask CHINO
	IR-CAEH□□	Φ 15/400mm		
	IR-CAEJ□□	Φ 8/200mm		
	IR-CAEZ□□	Special	Ask CHINO	

□ Connection
 - - - C : Connector
 T : Terminal
 □ External input/output (option)
 - - - N : None
 S : RS485
 5 : 4-20mA DC input
 J : Contact input (DI)
 K : Contact output (DO)

IR-CAB,IR-CAE

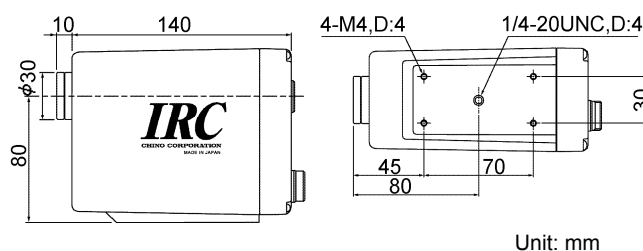

Unit: mm

Low temperature/short wavelength IR-CAE□□□□

Measuring system: Narrow-band radiation thermometer
 Element: PbSe
 Measuring wavelength: 4 μm
 Measuring range: 100 to 500°C (distance factor 200)
 Accuracy rating: ±3°C
 (at ε ≐ 1.0 and reference operating conditions)
 Repeatability: 1°C or less
 Stability: Temperature drift 0.15°C/°C
 At EMC test environment... ±10% of measuring range
 Resolution: 1°C
 Response time (95%): 0.02 sec
 Optics: Focusable lens type
 Sighting: Direct viewfinder
 Lens aperture: 20mm diameter
 Power consumption: Maximum 10VA
 (* The reference operating condition: 23°C±5°C, 35 to 75%RH)

Relation between measuring distance and diameter

Measuring distance: 0.5m to ∞
 Measuring diameter: Measuring distance/distance factor

Distance factor	Measuring distance(mm)		
	500	1000	2000
200	φ 2.5	φ 5	φ 10

Low to Medium temperature IR-CAP□□□□

Measuring system: Narrow-band radiation thermometer
 Element: PbS
 Measuring wavelength: 2 μm
 Measuring range: 80 to 250°C (distance factor 50)
 150 to 450°C (distance factor 200)
 200 to 800°C (distance factor 200 or 300)
 Accuracy rating: Lower than 500°C --- ±3°C
 More than 500°C --- ±5°C
 (at ε ≐ 1.0 and reference operating conditions)
 Repeatability: 1°C or less
 Stability: Temperature drift Lower than 500°C --- 0.15°C/°C
 Higher than 500°C --- 0.25%/°C
 At EMC test environment... ±10% of measuring range
 Resolution: 1°C
 Response time (95%): 0.02 sec
 Optics: Focusable lens type
 Sighting: Direct viewfinder
 Lens aperture: 20mm diameter
 Power consumption: Maximum 10VA
 (* The reference operating condition: 23°C±5°C, 35 to 75%RH)

Relation between measuring distance and diameter

Measuring distance: 0.5m to ∞
 Measuring diameter: Measuring distance/distance factor

Distance factor	Measuring distance(mm)		
	500	1000	2000
50	φ 10	φ 20	φ 40
200	φ 2.5	φ 5	φ 10
300	φ 1.7	φ 3.4	φ 6.7

Medium temperature IR-CAI□□□□

Measuring system: Narrow-band radiation thermometer
 Element: InGaAs
 Measuring wavelength: 1.55 μm
 Measuring range: 200 to 1000°C (distance factor 50)
 300 to 1600°C (distance factor 200 or 300)
 400 to 2000°C (with field diaphragm Φ 10, distance factor 200 or 300)
 Accuracy rating: Lower than 1000°C --- ±5°C
 1000 to 1500°C --- ±0.5% of measured value
 1500 to 2000°C --- ±1% of measured value
 More than 2000°C --- ±2% of measured value
 (at ε ≐ 1.0 and reference operating conditions)
 Repeatability: 0.2°C or less
 Temperature drift 0.1°C/°C or 0.015%/°C of measured value whichever larger.
 At EMC test environment... ±1% of measuring range
 Resolution: 0.5°C
 Response time (95%): 0.003 sec
 Optics: Focusable lens type
 Sighting: Direct viewfinder
 Lens aperture: 20mm diameter
 Power consumption: Maximum 2.4VA
 (* The reference operating condition: 23°C±5°C, 35 to 75%RH)

Relation between measuring distance and diameter

Measuring distance: 0.5m to ∞
 Measuring diameter: Measuring distance/distance factor

Distance factor	Measuring distance(mm)		
	500	1000	2000
50	φ 10	φ 20	φ 40
200	φ 2.5	φ 5	φ 10
300	φ 1.7	φ 3.4	φ 6.7

(With field diaphragm Φ 10)

Distance factor	Measuring distance(mm)		
	500	1000	2000
200	φ 2.5	φ 5	φ 10
300	φ 1.7	φ 3.4	φ 6.7

High temperature IR-CAS□□□□

Measuring system: Narrow-band radiation thermometer
 Element: Si
 Measuring wavelength: 0.9 μm
 Measuring range: 500 to 2000°C (distance factor 50)
 600 to 3000°C (distance factor 200 or 300)
 700 to 3500°C (with field diaphragm Φ 10, distance factor 200 or 300)
 Accuracy rating: Lower than 1000°C --- ±5°C
 1000 to 1500°C --- ±0.5% of measured value
 1500 to 2000°C --- ±1% of measured value
 More than 2000°C --- ±2% of measured value
 (at ε ≐ 1.0 and reference operating conditions)
 Repeatability: 0.2°C or less
 Stability: Temperature drift 0.1°C/°C or 0.015%/°C of measured value whichever larger.
 At EMC test environment... ±1% of measuring range
 Resolution: 0.5°C
 Response time (95%): 0.003 sec
 Optics: Focusable lens type
 Sighting: Direct viewfinder
 Lens aperture: 20mm diameter
 Power consumption: Maximum 2.4VA
 (* The reference operating condition: 23°C±5°C, 35 to 75%RH)

Relation between measuring distance and diameter

* Same as Medium Temperature Model IR-CAI

	Models	Distance factor	Measuring range
Low temperature/short wavelength	IR-CAE2□□□□	200	100 to 500°C
	IR-CAP0□□□□	50	80 to 250°C
Low to medium temperature	IR-CAP2□□□□	200	150 to 450°C or 200 to 800°C
	IR-CAP3□□□□	300	200 to 800°C
	IR-CAI0□□□□	50	200 to 1000°C
Medium temperature	IR-CAI2□□□□	200	300 to 1600°C
	IR-CAI3□□□□	300	300 to 1600°C
	IR-CAI7□□□□	with field diaphragm Φ 10, 200	400 to 2000°C
	IR-CAI8□□□□	with field diaphragm Φ 10, 300	400 to 2000°C
High temperature	IR-CAS0□□□□	50	500 to 2000°C
	IR-CAS2□□□□	200	600 to 3000°C
	IR-CAS3□□□□	300	600 to 3000°C
	IR-CAS7□□□□	with field diaphragm Φ 10, 200	700 to 3500°C
	IR-CAS8□□□□	with field diaphragm Φ 10, 300	700 to 3500°C

- Connection
 - C : Connector
 - T : Terminal
- External input/output (option)
 - N : None
 - S : RS485
 - 5 : 4-20mA DC input
 - J : Contact input (DI)
 - K : Contact output (DO)
- Sighting
 - Blank : With view finder (standard)
 - 3 : Built-in 300mm close-up lens (option) (190-300mm measuring distance)
 - 6 : Built-in 600mm close-up lens (option) (270-600mm measuring distance)
 - L : Laser targeting (option) *without view finder

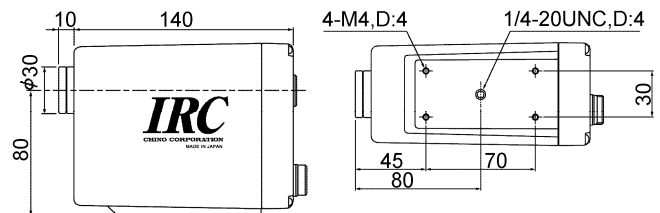

Unit: mm

Widest temperature IR-CAW□□□

Measuring system: Broadband/Narrow-band radiation thermometer
 Element: TP/InGaAs/Si
 Measuring wavelength: 8-13/1.55/0.9 μm
 Measuring range: 20 to 3000°C
 Accuracy rating:
 Lower than 1000°C --- ±5°C
 1000 to 1500°C --- ±0.5% of measured value
 1500 to 2000°C --- ±1% of measured value
 More than 2000°C --- ±2% of measured value
 (at ε ≐ 1.0 and reference operating conditions)
 Repeatability: 1°C or less
 Stability: Temperature drift
 Lower than 1000°C --- 0.2°C/°C
 Higher than 1000°C --- 0.02%/°C of measured value
 At EMC test environment... ±1% of measuring range
 Resolution: 1°C
 Response time (95%): 0.1 sec
 Optics: Fixed focus lens type
 Sighting: Direct viewfinder
 Lens aperture: 30mm diameter
 Power consumption: Maximum 2.4VA
 (* The reference operating condition: 23°C±5°C, 35 to 75%RH)

Short length/High speed IR-CAK□□□

Measuring system: Narrow-band radiation thermometer
 Element: PbSe (cooling type)
 Measuring wavelength: 4 μm
 Measuring range: 50 to 400 °C (displays from 0 °C but accuracy rating is guaranteed is from 50 °C)
 Accuracy rating: ±3°C
 (at ε ≐ 1.0 and reference operating conditions)
 Repeatability: 1.0°C or less
 Stability: Temperature drift 0.15 °C/°C
 Resolution: 1°C
 Response time (95%): 0.0015 sec
 Emissivity ratio setting: 1.9999 to 0.050
 Optics: Fixed focus lens type
 Sighting: Laser targeting without viewfinder
 Lens aperture: 30mm diameter
 Power consumption: Maximum 12VA
 (* The reference operating condition: 23°C±5°C, 35 to 75%RH)

Relation between measuring distance and diameter

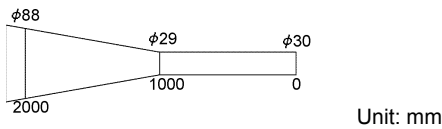

Models	Measuring diameter/Measuring distance	Measuring range	
IR-CAWV□□□	φ 29/1000mm	20 to 3000°C	with view finder
IR-CAWZ□□□	Special	Ask CHINO	

- Connection
 - C : Connector
 - T : Terminal
- External input/output (option)
 - N : None
 - S : RS485
 - 5 : 4-20mA DC input
 - J : Contact input (DI)
 - K : Contact output (DO)
- Sighting
 - Blank : With view finder (standard)
 - L : Laser targeting (option)
 - *without view finder

IR-CAW

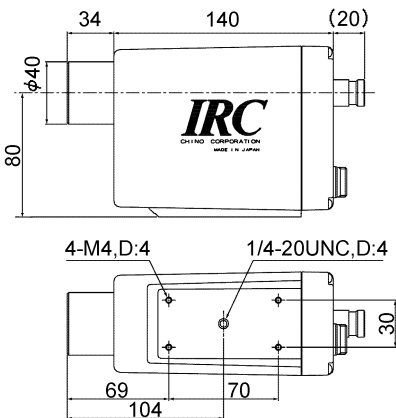

Relation between measuring distance and diameter

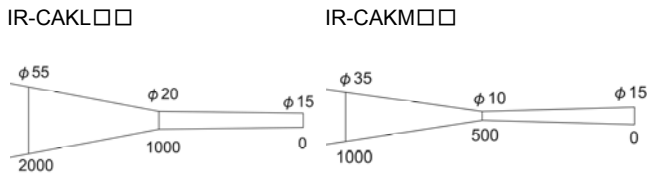

IR-CAKN□□

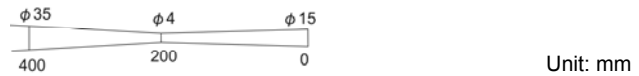

Models	Measuring diameter/Measuring distance
IR-CAKL□□□	φ 20/1000mm
IR-CAKM□□□	φ 10/500mm
IR-CAKN□□□	φ 4/200mm
IR-CAKZ□□□	Optional

- Connection
 - C : Connector
 - T : Terminal
- External input/output (option)
 - N : None
 - S : RS485

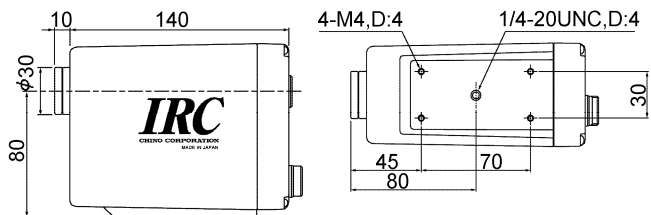

COMMON SPECIFICATIONS

Display	Temperature & parameter --- 4-digit LCD Unit --- °C or °F (Key switchable)
Emissivity setting	1.9999 to 0.050
Signal modulation	DELAY --- First-order lag (Time constant: 0.0 to 99.9 sec with 0.1 sec increment or 0.00 to 9.99 sec with 0.01 sec increment) Real signal must be set at 0 sec. PEAK --- Peak tracing (attenuation factor 0, 2, 5, 10°C/sec selectable) Peak hold must be set at 0sec.
Computation function	ZERO/SPAN adjustment, automatic emissivity computation, output correction
Analog output	4 to 20mA DC isolated output Load resistance: Less than 500Ω Accuracy rating: ±0.2% of output range Resolution: 0.04% of output range Scaling: Programmable in measuring range Dummy output: Programmable within 0 to 100% of analog output
Parameter setting key	Operator mode --- Emissivity, signal modulation, alarm, others Engineering mode --- Measuring unit, output scaling, ZERO/SPAN, reference temperature for automatic emissivity computation, output correction and other options.
Self-diagnostic	Thermometer temperature abnormal, parameter error
Working temperature	0 to 50°C
Power supply	24V DC (allowable voltage fluctuation 22 to 28V DC) Recommended power supply unit ● IR-ZFEP (S82K-01524) ● IR-GZ ● IR-GC
Connections	Terminal or connector
Casing	Aluminum
Weight	Approx 1.3Kg
CE marking (connector connection only)	EMC directive EN61326+A1 Emission class A Immunity Annex A * The product complies when in use of exclusive power supply unit and connecting cable up to 30m. (* The reference operating condition: 23°C±5°C, 35 to 75%RH)

OPTIONS

Option	Contents
Communications interface*	RS485: Sending of measuring data, and sending/receiving of parameters
Analog output*	4-20mA input signal: Selection of emissivity remote setting or automatic emissivity computation
Contact input*	1 point: Peak hold reset or sample hold. Dry contact or open collector
Contact output*	1 point: High(low) alarm or error signal. Photo coupler 30VDC 50mA max
Laser targeting	Built-in semiconductor laser emitter. 1mW or lower (645nm), class2. No viewfinder model.

* Only one kind of option to be selected.



CAUTIONS FOR LASER TARGETING MODELS
- Laser may damage your eyes. Don't stare into a laser beam.
- Make sure to prevent from the reflection when you want to measure an object equivalent to mirror surface like a brilliant metal.

SETTING/DISPLAY PART

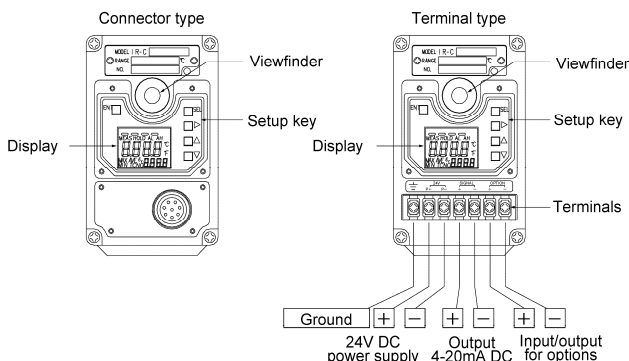

CONNECTIVITY

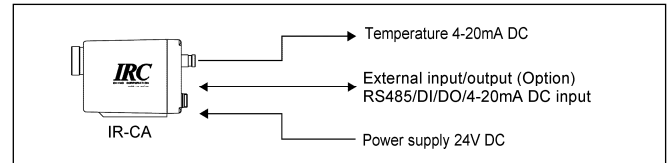

Remote setup system

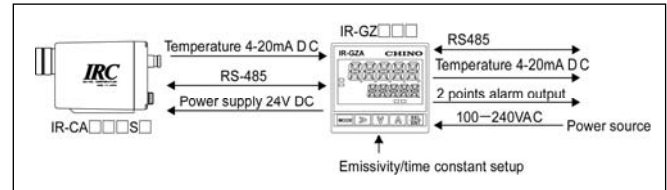

* Only IR-CAI/CAS/CAQ/CAW can be connected.
Separate DC power supply is required for other models.

Data Acquisition Software (option)

This PC software records measuring data for the IR-CA.

Model

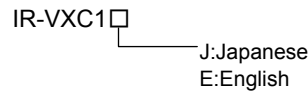

Specifications

Environment	OS	Windows 7/10
	Hard drive	20MB or more
	Memory	16MB or more
	Drive	Floppy disk drive
Function	Measuring data display Data storing, replay, print 1-3 units connectable	
Measuring mode	Real time trend mode	

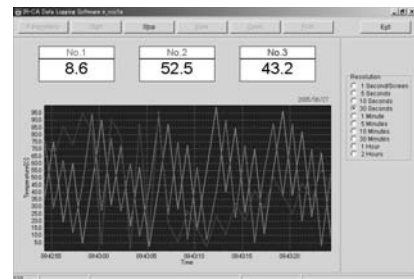

Connectivity

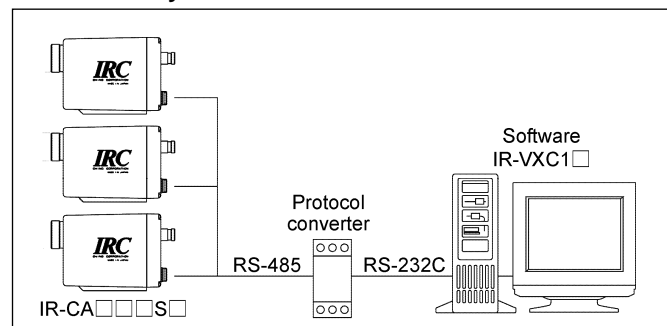

SPECIFICATIONS

Film Temperature IR-CAN□□□□, CAM□□□□

Measuring system: Narrow-band radiation thermometer
 Element: IR-CAN ---PE
 IR-CAM ---PbSe
 Measuring wavelength: IR-CAN --- 8 μm
 IR-CAM --- 3.43 μm
 Measuring range: IR-CAN ---0 to 300°C
 IR-CAM ---30 to 300°C
 Accuracy rating: Lower than 200°C --- ±2°C
 More than 200°C --- ±0.1% of measured value
 (at ε ≐ 1.0 and reference operating conditions)
 Repeatability: 1°C or less
 Stability: Temperature drift 0.15°C/°C
 At EMC test environment...IR-CAN: ±15% of measuring range
 IR-CAM: ±10% of measuring range
 Resolution: 1°C
 Response time (95%): 1 sec
 Optics: Fixed focus lens type
 Sighting: Laser spot without viewfinder
 Lens aperture: 15mm diameter
 Power consumption: IR-CAN --- Maximum 5VA
 IR-CAM --- Maximum 10VA
 (* The reference operating condition: 23°C ±5°C, 35 to 75%RH)

Semiconductor IR-CAT□□□□, IR-CAU□□□□

Measuring system: Narrow-band radiation thermometer
 Element: Si
 Measuring wavelength: IR-CAT --- 0.6 to 0.96 μm
 IR-CAU --- 0.6 to 0.9 μm
 Measuring range: IR-CAT --- 400 to 800°C (distance factor 100)
 500 to 1000°C (distance factor 200)
 600 to 1200°C (distance factor 200)
 IR-CAU --- 400 to 800°C (distance factor 100)
 500 to 1000°C (distance factor 200)
 (at ε ≐ 1.0 and reference operating conditions)
 Accuracy rating: Lower than 600°C --- ±3°C
 More than 600°C --- ±0.5% of measured value
 Repeatability: 0.5°C or less
 Stability: Temperature drift
 Lower than 700°C ---0.1°C/°C
 More than 700°C --- 0.015%/°C of measured value
 At EMC test environment...±10% of measuring range
 Resolution: 0.5°C
 Response time (95%): 0.04 sec
 Optics: Focusable lens type
 Sighting: Direct viewfinder
 Lens aperture: 20mm diameter
 Power consumption: Maximum 10VA
 (* The reference operating condition: 23°C ±5°C, 35 to 75%RH)

Relation between measuring distance and diameter

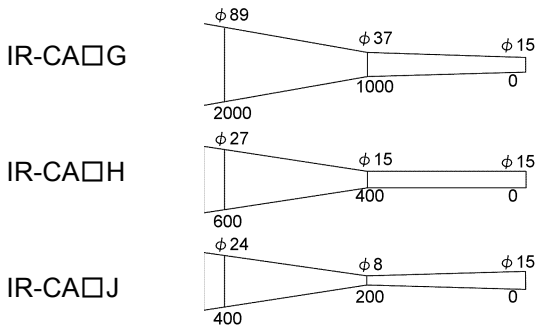

Relation between measuring distance and diameter

Measuring distance: 0.5m to ∞
 Measuring diameter: Measuring distance/distance factor

Distance factor	Measuring distance(mm)		
	500	1000	2000
100	φ5	φ10	φ20
200	φ2.5	φ5	φ10

Measurement Inside Furnace object IR-CAR□□□□

Measuring system: Narrow-band radiation thermometer
 Element: PbSe
 Measuring wavelength: 3.8 μm
 Measuring range: 350 to 1100°C (distance factor 100)
 450 to 1300°C (distance factor 200)
 500 to 1500°C (distance factor 200)
 Accuracy rating: Lower than 1000°C --- ±5°C
 More than 1000°C --- ±0.5% of measured value
 (at ε ≐ 1.0 and reference operating conditions)
 Repeatability: 1°C or less
 Stability: Temperature drift
 Lower than 1000°C ---0.2°C/°C
 More than 1000°C --- 0.02%/°C of measured value
 At EMC test environment...±10% of measuring range
 Resolution: 1°C
 Response time (95%): 0.02 sec
 Optics: Focusable lens type
 Sighting: Direct viewfinder
 Lens aperture: 20mm diameter
 Power consumption: Maximum 10VA
 (* The reference operating condition: 23°C ±5°C, 35 to 75%RH)

Glass Temperature IR-CAG□□□□

Measuring system: Narrow-band radiation thermometer
 Element: MCT
 Measuring wavelength: 5 μm
 Measuring range: 100 to 800°C (distance factor 50)
 200 to 1800°C (distance factor 100)
 400 to 2800°C (distance factor 200)
 Accuracy rating: Lower than 1000°C --- ±5°C
 1000 to 1500°C --- ±0.5% of measured value
 1500 to 2000°C --- ±1% of measured value
 More than 2000°C --- ±2% of measured value
 (at ε ≐ 1.0 and reference operating conditions)
 Repeatability: 1°C or less
 Temperature drift: Lower than 1000°C --- 0.2°C/°C
 More than 1000°C --- 0.02%/°C of measured value
 Resolution: 1°C
 Response time (95%): 0.1 sec
 Optics: Focusable lens type
 Sighting: Direct viewfinder
 Lens aperture: 20mm diameter
 Power consumption: Maximum 10VA
 (* The reference operating condition: 23°C ±5°C, 35 to 75%RH)

Relation between measuring distance and diameter

Measuring distance: 0.5m to ∞
 Measuring diameter: Measuring distance/distance factor

Distance factor	Measuring distance(mm)		
	500	1000	2000
50	φ10	φ20	φ40
100	φ5	φ10	φ20
200	φ2.5	φ5	φ10

Relation between measuring distance and diameter

Measuring distance: 0.5m to ∞
 Measuring diameter: Measuring distance/distance factor

Distance factor	Measuring distance(mm)		
	500	1000	2000
100	φ5	φ10	φ20
200	φ2.5	φ5	φ10

Food industry IR-CAFX□□ (non-CE approval)

Measuring system: Narrow-band radiation thermometer
 Element: PbSe
 Measuring wavelength: 4 μm
 Measuring range: 60 to 100°C
 Accuracy rating: 70 to 90°C ---±1.0°C
 Except 70 to 90°C ---±2°C
 (at ε = 1.0 and reference operating conditions)
 Repeatability: 0.3°C
 Temperature drift: 0.04°C /°C
 Resolution: 0.2°C
 Response time (95%): 0.01 sec
 Optics: Fixed focus lens type
 Sighting: Laser targeting without viewfinder
 Lens aperture: 15mm diameter
 Power consumption: Maximum 10VA
 (* The reference operating condition: 23°C±5°C, 35 to 75%RH)

Relation between measuring distance

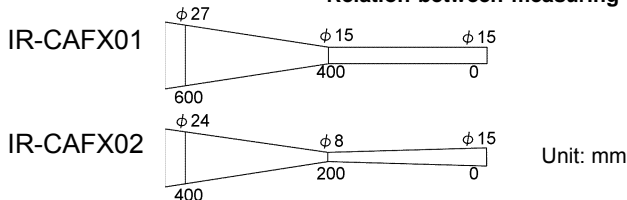

Models

Polyester film

Models	Measuring diameter/Measuring distance	Measuring range	Standard sighting
IR-CANG□□	φ 37/1000mm	0 to 300°C	Laser targeting (without viewfinder)
IR-CANH□□	φ 15/400mm		
IR-CANJ□□	φ 8/200mm		
IR-CANZ□□	Special (Ask CHINO)		

Polyethylene film

Models	Measuring diameter/Measuring distance	Measuring range	Standard sighting
IR-CAMG□□	φ 37/1000mm	30 to 300°C	Laser targeting (without viewfinder)
IR-CAMH□□	φ 15/400mm		
IR-CAMJ□□	φ 8/200mm		
IR-CAMZ□□	Special (Ask CHINO)		

- Connection
 - C: Connector
 - T: Terminal
- External input/output (option)
 - N: None
 - S: RS485
 - 5: 4-20mA DC input
 - J: Contact input (DI)
 - K: Contact output (DO)

Intrafurnace object

Models	Distance factor	Measuring range	Standard sighting
IR-CAR1□□□	100	350 to 1100°C	Direct viewfinder
IR-CAR2□□□	200	450 to 1300°C	
IR-CAR2□□□		500 to 1500°C	

Glass

Models	Distance factor	Measuring range	Standard sighting
IR-CAG0□□□	50	100 to 800°C	Direct viewfinder
IR-CAG1□□□	100	200 to 1800°C	
IR-CAG2□□□	200	400 to 2800°C	

Semiconductor/Silicon

Models	Distance factor	Measuring range	Standard sighting
IR-CAT1□□□	100	400 to 800°C	Direct viewfinder
IR-CAT2□□□	200	500 to 1000°C	
IR-CAT2□□□		600 to 1200°C	

Semiconductor/InGaAs

Models	Distance factor	Measuring range	Standard sighting
IR-CAU1□□□	100	400 to 800°C	Direct viewfinder
IR-CAU2□□□	200	500 to 1000°C	

- Connection
 - C: Connector
 - T: Terminal
- External input/output (option)
 - N: None
 - S: RS485
 - 5: 4-20mA DC input
 - J: Contact input (DI)
 - K: Contact output (DO)
- Sighting
 - Blank: With view finder (standard)
 - L: Laser targeting (option) *without view finder

EXTERNAL DIMENSIONS

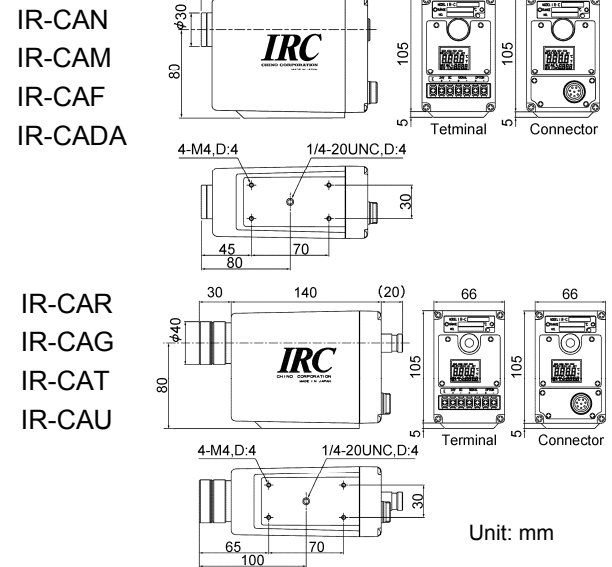

HMD (Hot Metal Detector) IR-CADAC01 (non-CE approval)

Output is turned ON when hot metal enters the optical sensing path and exceeds the preset threshold level.



Features

- Detect luminance temperature of 100 to 550°C or equivalent.
- Remote object detection
- External detect level setup by 4-20mA DC

Model

IR-CADAC01

Connectivity

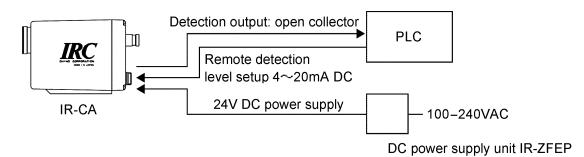

Specifications

Detection system	Radiation luminance threshold judgement
Detection	Luminance temperature of 100 to 550°C or equivalent
Response time	0.1 sec
Output	Open collector, normally OFF
Detection level	Built-in trimmer or external 4-20mA DC
Optics	Fixed focus lens type
Measuring spot size	Φ 150mm/15m
Targeting	Direct viewfinder (reverse view)
Working temperature	0 to 50°C
Power supply	24V DC (22-28V DC)
Accessory	Airpurg hood (sold separately)

SETTING DISPLAY UNIT IR-GZA



Setting display unit IR-GZA

Wall-mount box IR-ZGBW

The IR-GZA is combined with the IR-CA with optional RS485, programs parameters, displays measuring data and supplies 24V DC power to the IR-CA.

Connectivity

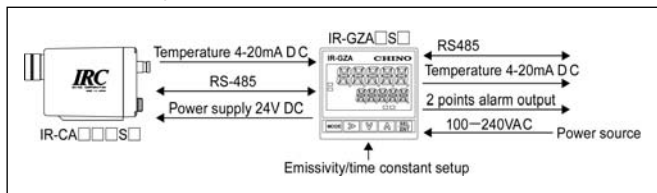

Model

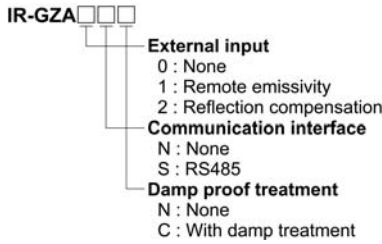

Communications interface:

RS485 (Send measuring data, send/receive each setting parameters, option)

Connectable number of IR-CA:

Maximum 1 unit (Up to 2 units for IR-GZA□□, prepare separate power supply for the second unit)

Power supply to IR-CA:

24V DC 830mA

Power supply:

100 to 240V AC, 50/60Hz

Power consumption:

100VAC Max. 28VA, 240VAC Max. 36VA

Working temperature:

-10 to 50°C

Working humidity:

20 to 90%RH (No dew condensation)

Casing:

Nonflammable Polycarbonate

Installation:

Panel mount type

Weight:

Approx 0.5Kg

CE Marking:

EMC directive EN61326+A1

Low voltage EN61010-1+A2

Overvoltage category II,

Pollution level 2

Stability at EMC test environment...±10%

External dimensions

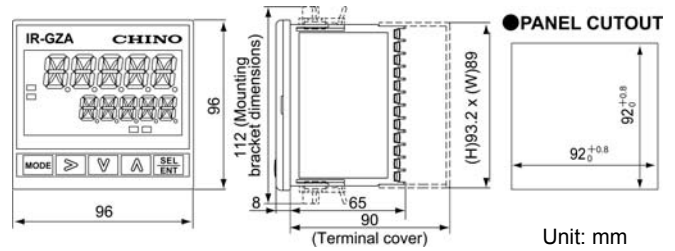

Wall-mount box IR-ZGBW (Purchase IR-GZA separately)

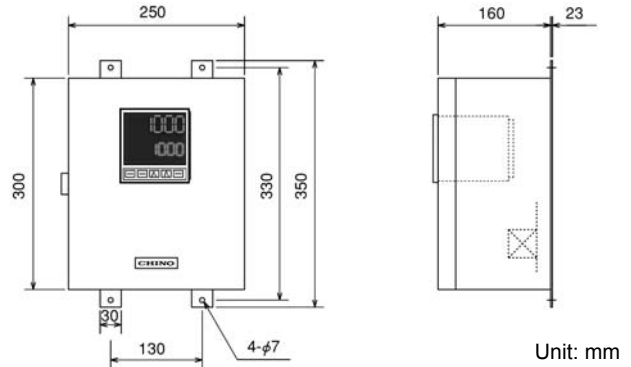

SPECIFICATIONS

Emissivity (ratio) setting:	1.999 to 0.050
Thermometer input:	RS485
Signal modulation:	DELAY --- First-order lag (Time constant: 0.0 to 99.9 sec with 0.1 sec increment or 0.00 to 9.99 sec with 0.01 sec increment) Real signal must be set at 0 sec. PEAK --- Peak tracing (attenuation degree 0.1 to 10°C /sec selectable, 0.1s increment)
Analog input:	Remote emissivity setup or Reflection compensation
Display:	Temperature, Status display
Analog output:	Output 1: 4 to 20mA DC IR-GZ output (Load resistance: less than 600 Ω) Output 2: 4 to 20mA DC IR-CA output (Load resistance: less than 500 Ω)
Output renewal cycle:	Output 1: 100ms Output 2: Depending on the model of IR-CA
Output accuracy ratings:	Output 1: ±0.3% of output range Output 2: Depending on the model of IR-CA
	Event output: 2 points Select 2 points within "High temperature alarm", "High-high temperature alarm", "Low temperature alarm", "Low-low temperature alarm" and "self diagnostic function"
	Relay a-contact: High, High-high, Low, Low-low Relay b-contact: Self diagnostic function
	Contact capacity 240V AC 1.5A 30V DC 1.5A

Terminal diagrams

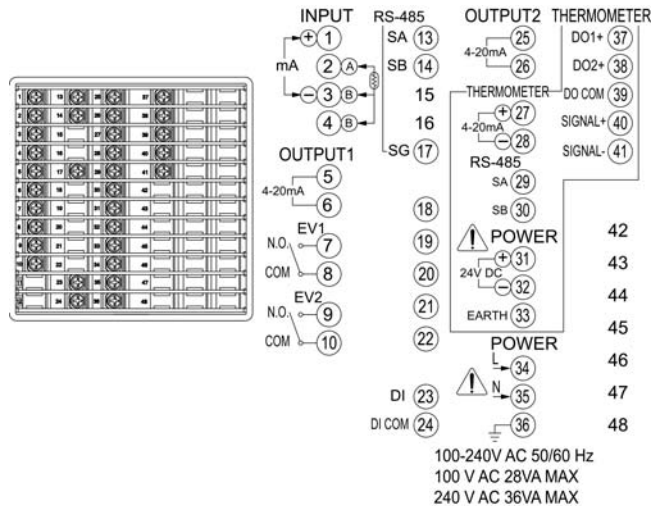



■ ACCESSORIES

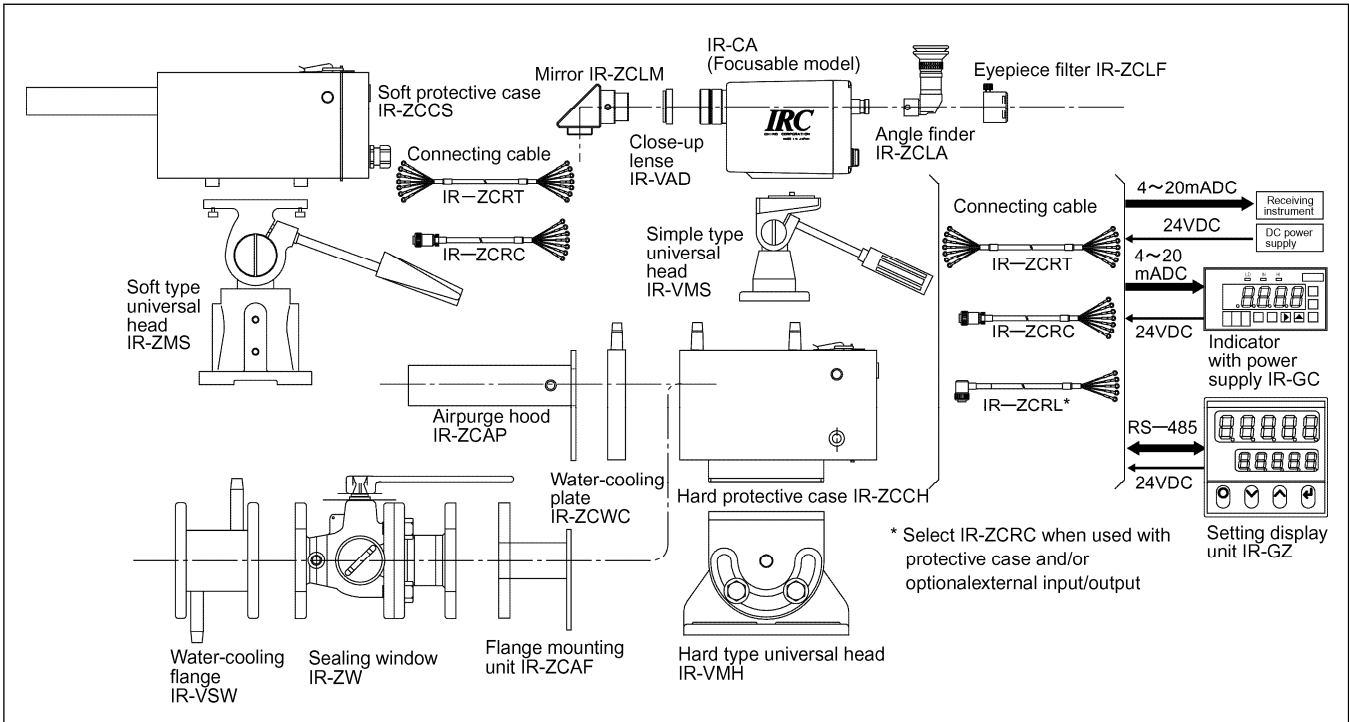

■ Soft protective case IR-ZCCST (terminal type)

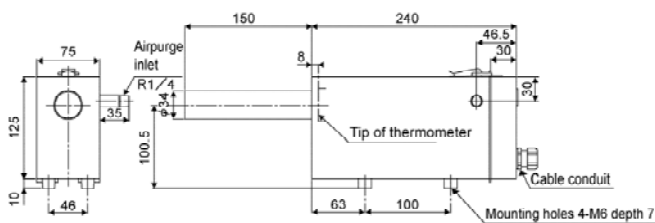

The soft protective case IR-ZCCST is an exclusive accessory for the IR-CA terminal type to protect the thermometer from smoke, dust, etc. at the installation site. This unit provides airpurge to remove smoke and dust for keeping the lens clean. Use clean dried air.

■ Hard protective case IR-ZCCHT (terminal type)

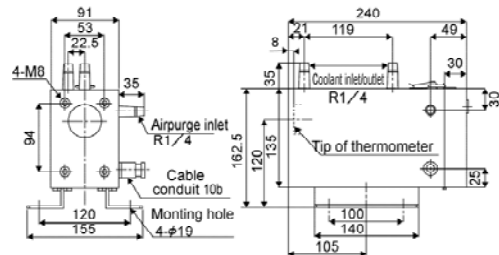

The hard protective case IR-ZCCHT is to protect the IR-CA terminal type from high-temperature, humidity, smoke, dust, fume, etc. This unit provides airpurge and water-cooling to operate the thermometer properly in harsh environment.

■ Soft protective case IR-ZCCSC (connector type)

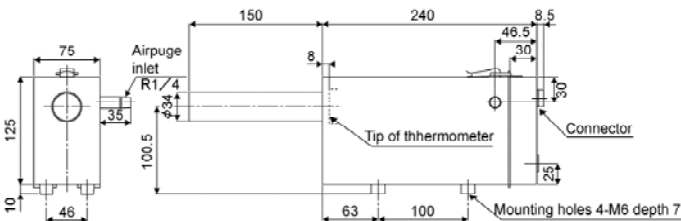

The soft protective case IR-ZCCSC is an exclusive accessory for the IR-CA connector type to protect the thermometer from smoke, dust, etc. at the installation site. This unit provides airpurge to remove smoke and dust for keeping the lens clean. Use clean dried air.

■ Hard protective case IR-ZCCHC (connector type)

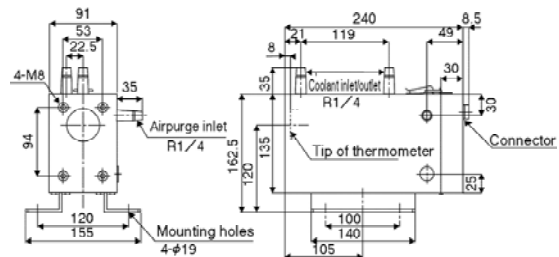

The hard protective case IR-ZCCHC is to protect the IR-CA connector type from high-temperature, humidity, smoke, dust, fume, etc. This unit provides airpurge and water-cooling to operate the thermometer properly in harsh environment.

■ **Airpurge Hood IR-ZCAP**
(for IR-ZCCH□)

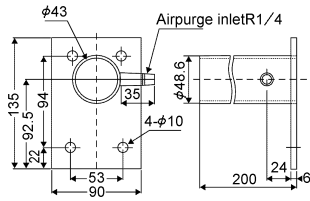

The airpurge hood is used to disperse dust and fume for keeping the light path. It is mounted to the front of the hard protective case IR-ZCCH□. Use clean dried air.

■ **Front water-cooling plate IR-ZCWC**
(for IR-ZCCH□)

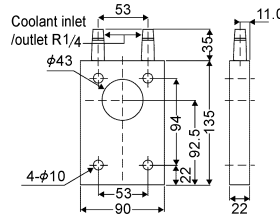

The front water-cooling plate is used when installing the thermometer under high ambient temperature. It is mounted to the front of the hard protective case IR-ZCCH□. It is applicable when the thermal radiation is intense from the front.

■ **Flange mounting unit IR-ZCAF**
(for IR-ZCCH□)

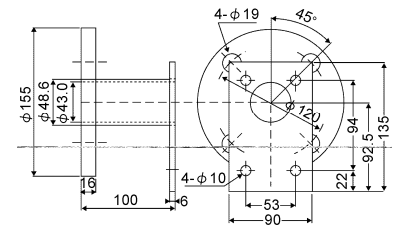

The flange mounting unit is used for fixing at the front of hard protective case IR-VCCH□. It is also applicable for mounting the IR-VSW and IR-ZW□.

■ **Water-cooling flange IR-VSW**

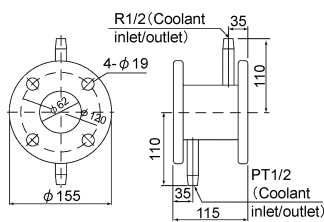

■ **Sealing window IR-ZW□**

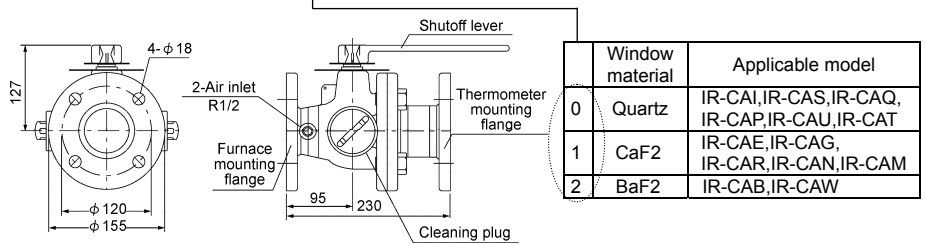

	Window material	Applicable model
0	Quartz	IR-CAI,IR-CAS,IR-CAQ,IR-CAP,IR-CAU,IR-CAT
1	CaF ₂	IR-CAE,IR-CAG,IR-CAR,IR-CAN,IR-CAM
2	BaF ₂	IR-CAB,IR-CAW

■ **Connecting cable**

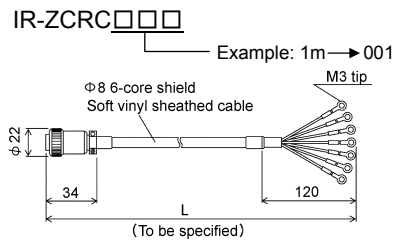

■ **Close-up lens IR-VAD□□□ (for focusable model)**

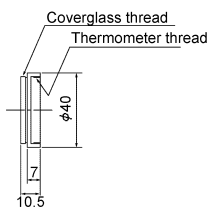

Models	Measuring distance	Applicable model
IR-VAD30A	190 to 300 mm	IR-CAI,IR-CAS,IR-CAQ,IR-CAP,IR-CAU,IR-CAT
IR-VAD30G	190 to 300 mm	IR-CAE(Focusable model),IR-CAG,IR-CAR
IR-VAD60A	270 to 600 mm	IR-CAI,IR-CAS,IR-CAQ,IR-CAP,IR-CAU,IR-CAT
IR-VAD60G	270 to 600 mm	IR-CAE(Focusable model),IR-CAG,IR-CAR

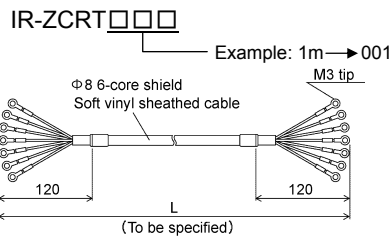

■ **Mirror IR-ZCLM**

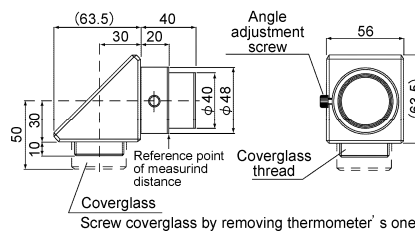

■ **Eyepiece filter IR-ZCLF**

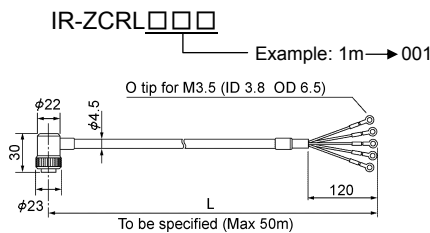
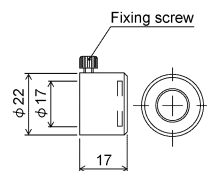

■ **Angle finder IR-ZCLA**

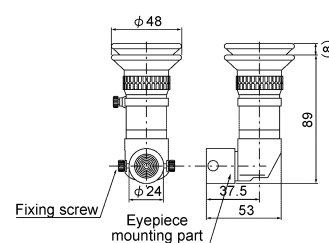

■ **Tripod IR-ZBMT**

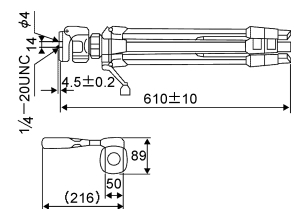

■ **Universal Head**

■ **Simple type IR-VMS**

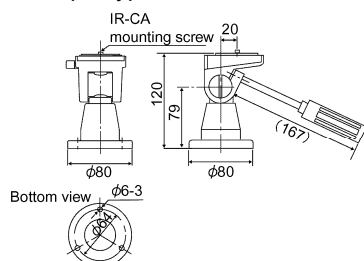

■ **Soft type IR-ZMS**

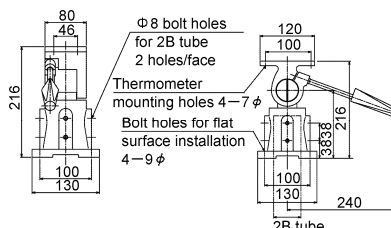

■ **Hard type IR-VMH**

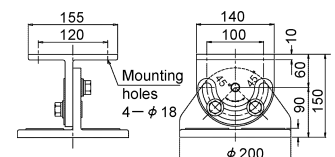

Specifications subject to change without notice. Printed in Japan (I) 2018. 12 Recycled Paper

CHINO CORPORATION

32-8, KUMANO-CHO, ITABASHI-KU, TOKYO 173-8632

PHONE: +81-3-3956-2171

FAX: +81-3-3956-0915

E-mail: inter@chino.co.jp

Website: <http://www.chino.co.jp>
